



©2019 DESIGNED BY PLAYSTEAM EDUCATION LIMITED, LONDON.
WEBSITE: WWW.PLAYSTEAM.COM EMAIL: INFO@PLAYSTEAM.COM ADDRESS: SUITE 35 - 36 THE DESIGNWORKS,
PARK PARADE, LONDON, NW10 4HT. MANUFACTURED BY HANGZHOU ZT MODEL COMPANY LIMITED. ADDRESS: NO 6
MINGDE RD., PUYAN, BINJIANG, HANGZHOU, CHINA.

PLAY • READ • INSPIRE

THE LEARNING BOOKLET

— RUBBERBAND AEROPLANE SCIENCE —

PLAY STEAM
PLAYSTEAM.COM

Rubberband Power

WARNING:
CHOKING HAZARD - Small parts,
Not for children under 3 years.

AGES **14+**

PLAY

PLAY • READ • INSPIRE

STEAM

TABLE OF CONTENTS

Warning Message	01
Package Contents	05
Installation Instructions	08
Fun Facts	19
Activities	35

WARNING MESSAGE

GENERAL WARNING

Before you begin, please read through the instructions together with your children. Make sure you understand the safety messages. Please keep the packaging and instructions, as they contain important information.

This kit is designed for children over 14 years of age. This product contains small parts which may pose a choking hazard. It is not suitable for children under 3 years old. Please keep individual parts and the fully-assembled product away from children under 3 years of age.

Screws and other metal parts may have sharp edges. Children should have adult supervision when assembling the product. Do not touch propellers as they rotate at high speeds.

This kit can be used in large indoor spaces and outdoors in low winds. Water and rain could damage parts of the airplane.

Last but not least, please clean the parts and finished product with a damp cloth. Do not use any soap or cleaning solutions.

1 | WARNING MESSAGE





Read to be inspired!



2 | PACKAGE CONTENTS



Package Contents

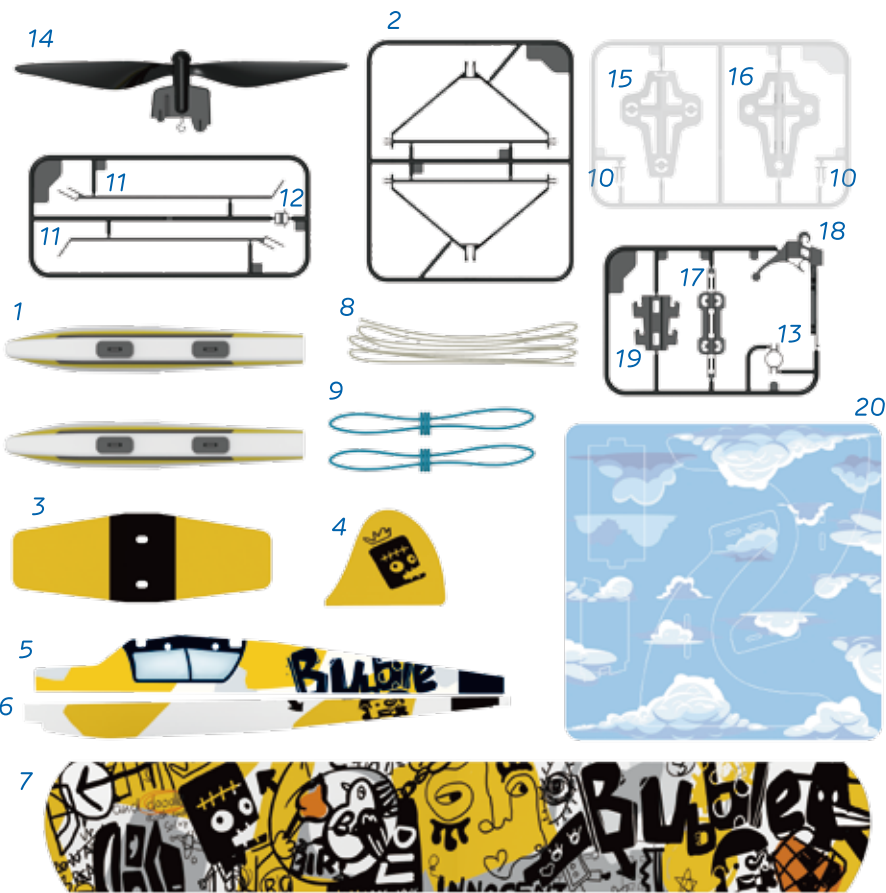

Serial	Name	Quantity	Serial	Name	Quantity
1	Floats	2	11	Wing strut	2
2	Float struts	2	12	Strut support	1
3	Horizontal stabilizer	1	13	Band guide	1
4	Vertical stabilizer	1	14	Propeller unit	1
5	Fuselage (upper)	1	15	Upper wing support	1
6	Fuselage (lower)	1	16	Lower wing support	1
7	Wing	1	17	Upper tail support	1
8	Standard rubber band	1	18	Lower tail support	1
9	Short rubber band	2	19	Plane holder	1
10	Fastener	2	20	Stand	1



Assemble the Plane

- 1 Insert the lower wing support onto the upper fuselage paying attention to match the holes.

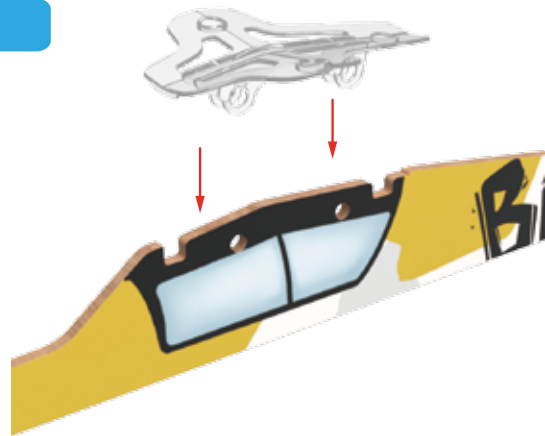

- 2 Snap the fasteners to fix the wing support to the fuselage.

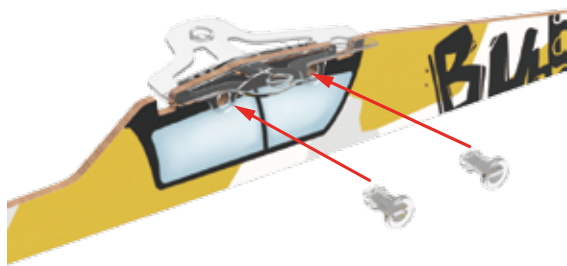

- 3 Slightly round the wing just behind the leading edge into a cambered airfoil shape (do not bend excessively as the wing could break).

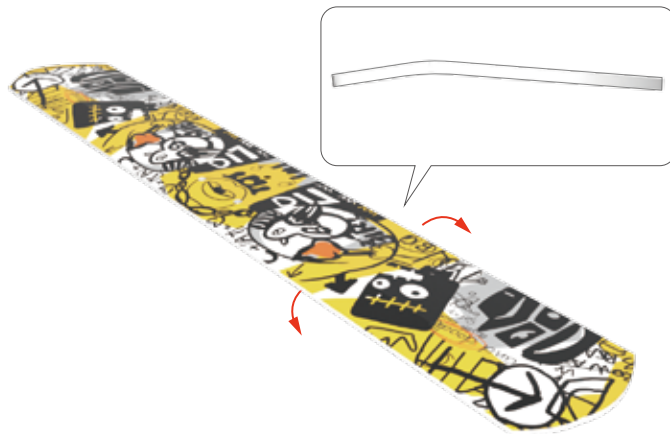

- 4 Attach the upper wing support to the wing.

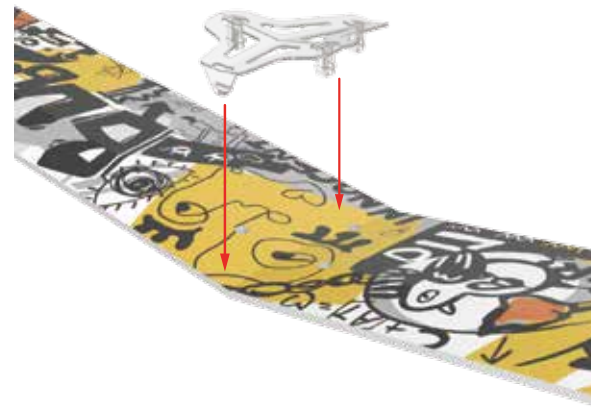

- 5 Then, snap wings assembly onto the lower wing support.





6 Snap the upper tail support onto the lower tail support passing through the horizontal stabilizer.

7 Insert the vertical stabilizer into the slot.



8 Insert the rear half of the fuselage into the lower and upper tail support sections.



9 Connect the upper and lower fuselage with the band guide.



10 Bring both ends of the standard rubber band together and tie them into a knot. Double the rubber band to form two loops. Hook the knot to the tail to prevent it from rubbing against the fuselage. Pass the rubber band through the band guide.

- 11 Hook the rubber band to the propeller shaft while inserting the upper and lower parts of the fuselage into their corresponding slots in the propeller unit.



- 12 Insert the strut support into the fuselage. Then attach one end of the wing struts to the strut support and the other end to the wing.

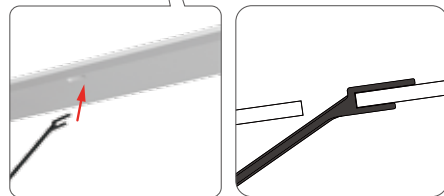

Detailed view of the strut attached to the wing.

- 13 Snap the floats onto float struts.

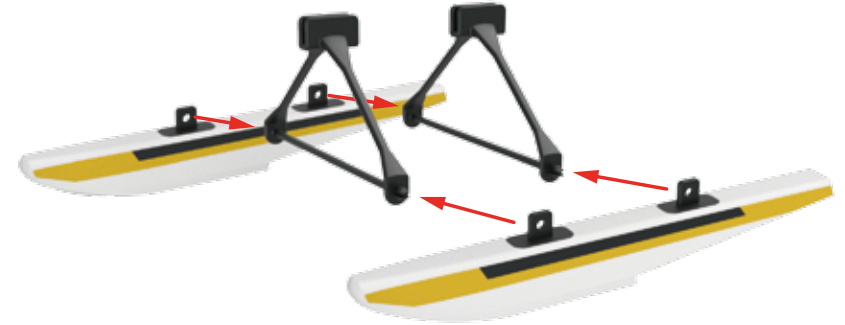

- 14 Attach the float struts to the lower fuselage.





Assemble the Stand

- 1 Detach the stand parts and remove the waste material.



- 2 Assemble the stand as shown. Place the plane holder on the top with the slot facing upward.



- 3 Push the plane holder to lock it.

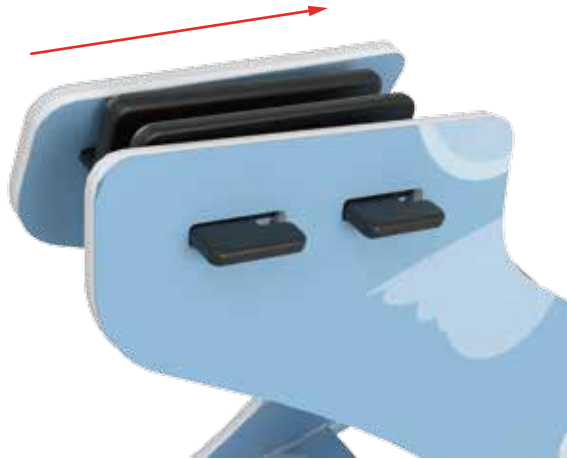

- 4 You can place your plane on the stand when you are not using it.



4 | FUN FACTS



HOW DOES IT WORK?

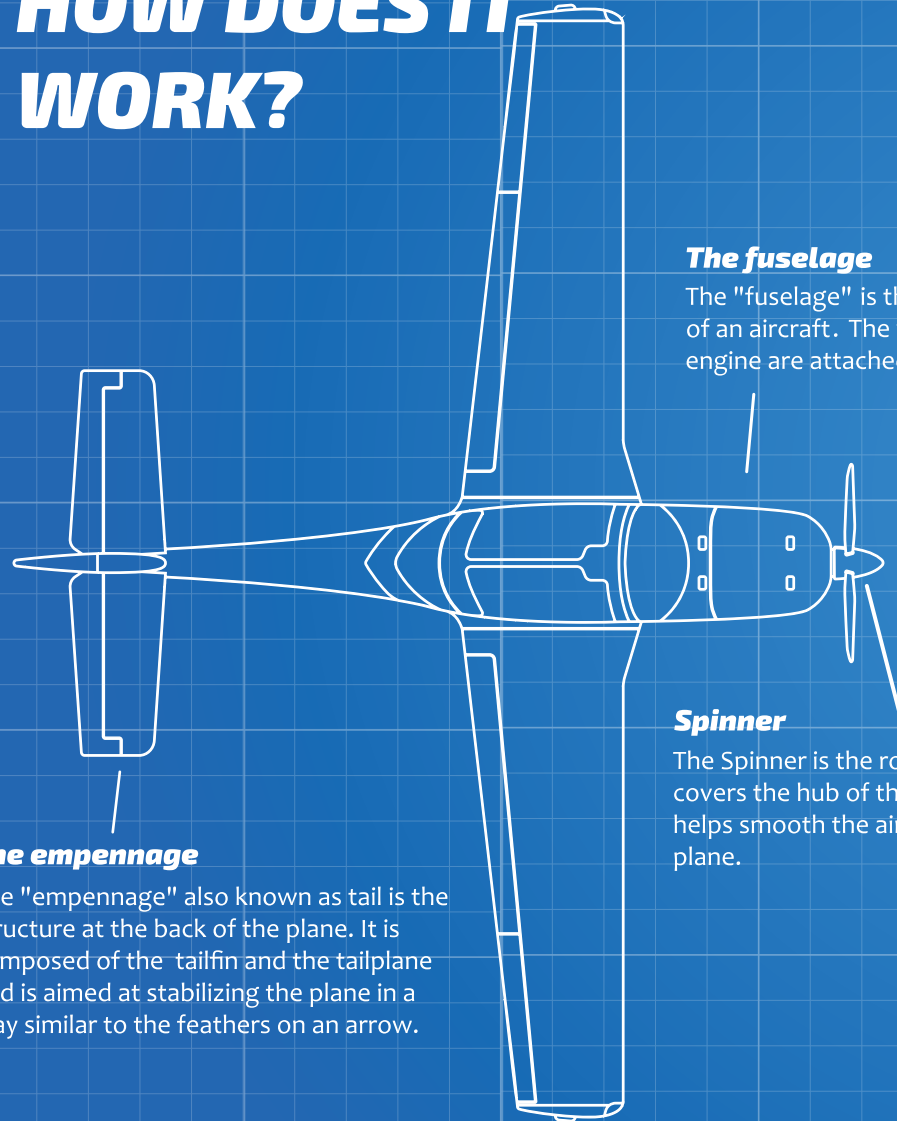

The empennage

The "empennage" also known as tail is the structure at the back of the plane. It is composed of the tailfin and the tailplane and is aimed at stabilizing the plane in a way similar to the feathers on an arrow.

The fuselage

The "fuselage" is the main body of an aircraft. The wings, tail, and engine are attached to the fuselage.

Spinner

The Spinner is the rounded part that covers the hub of the propeller. It helps smooth the airflow over the plane.

Propeller

The propeller is composed of turning blades that produce thrust when powered by the engine.

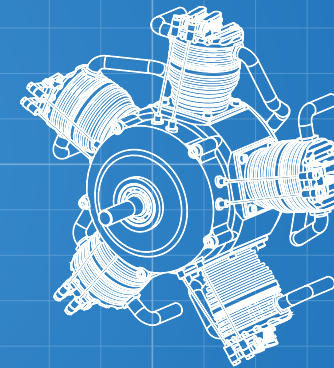
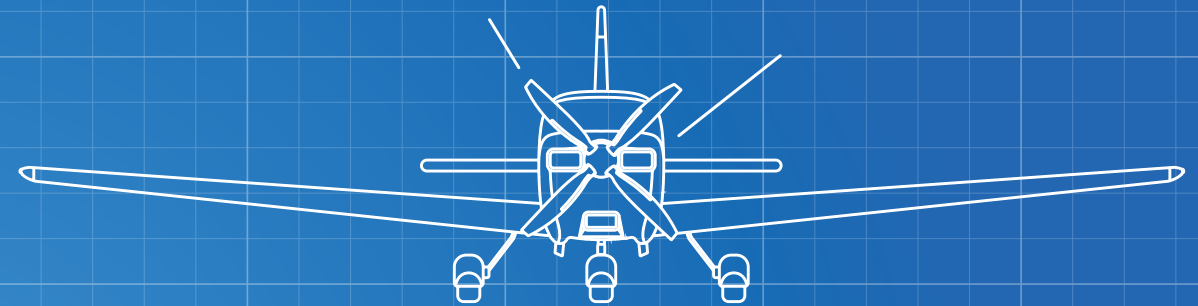

Engine

The engine of an aircraft is what provides the mechanical power to turn the propeller. In the model you have, the rubber band acts as the aircraft engine. Once wound up, it makes the propeller spin transforming "Elastic Energy" into "Mechanical Energy".

Cockpit

Cockpit - where the pilot sits while flying the plane. You can find all the controls and instrumentation there.

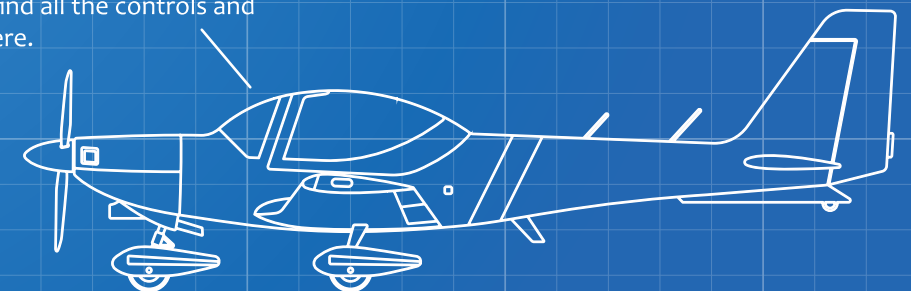

HOW DOES IT FLY

The basic principle of airplanes.

Do you know what maintain airplanes in the air? It is due to what physicists call "Bernoulli Principle". To put it in simple terms, this principle states that pressure is low when air is moving fast and high otherwise.

Not sure what it means?

You can try this little experiment:

Take a sheet of paper and place it at the edge of a table as illustrated. Place a hairdryer on the table and blow air across the top of the sheet of paper. The paper will lift up. This is because the air above the paper moves much faster than the air below. Thus, the pressure above is much lower and the sheet lifts up.

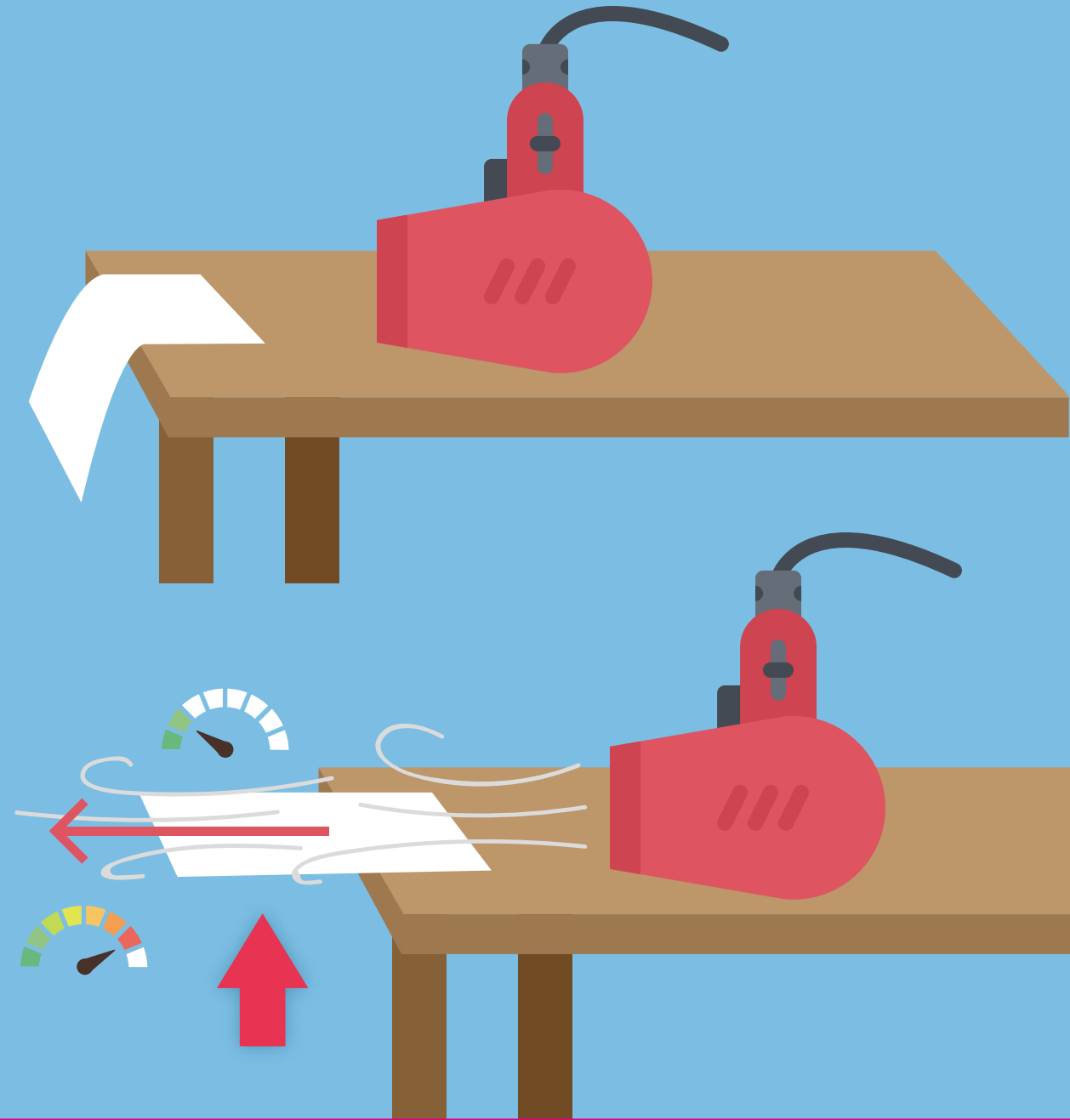

HOW DOES THAT WORK WITH OUR PLANE?

When air passes around the wings, the air passing on top of the wing goes faster than the air passing under because it has a greater distance to travel. Thus the pressure under the wing is higher than above. This difference of pressure pushes the airplane upward, this is what physicists call "Lift".

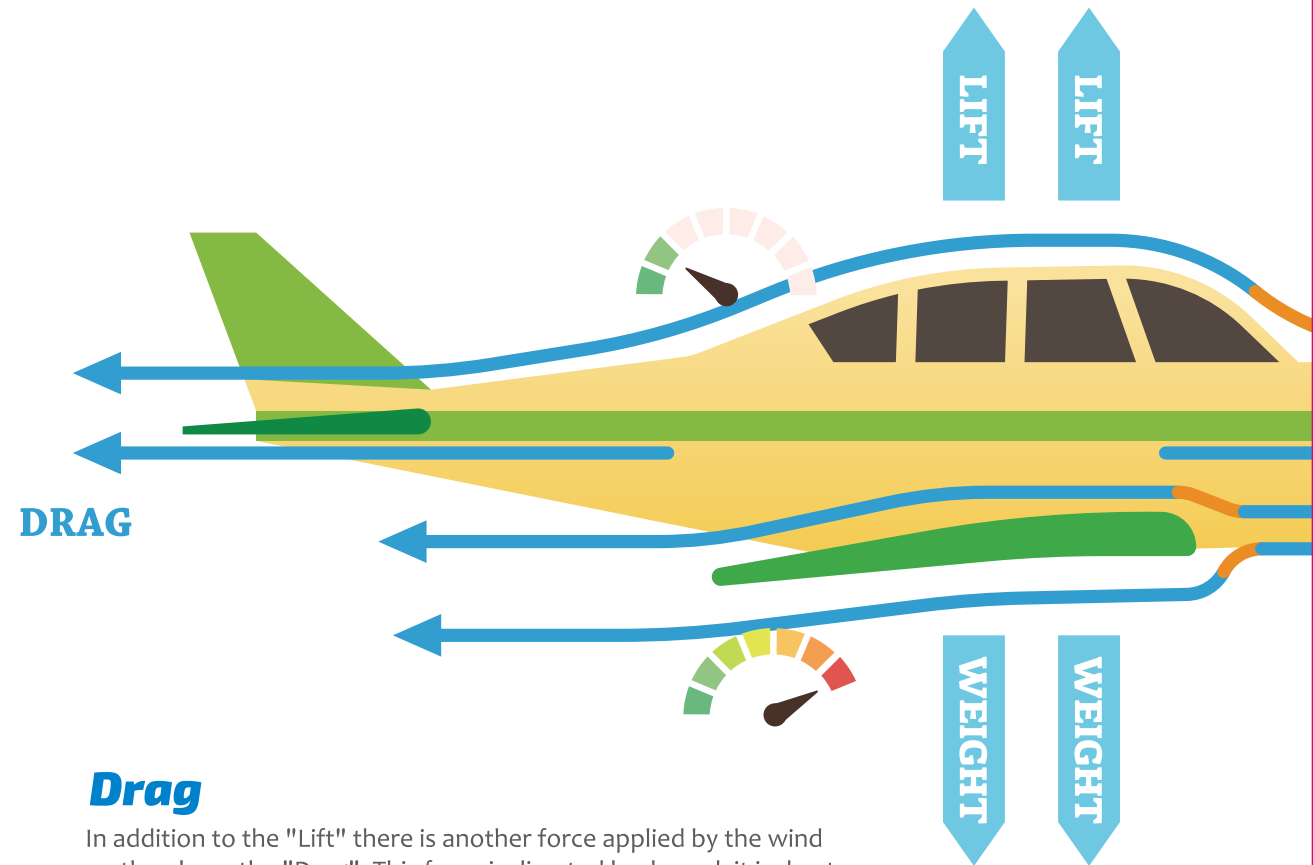
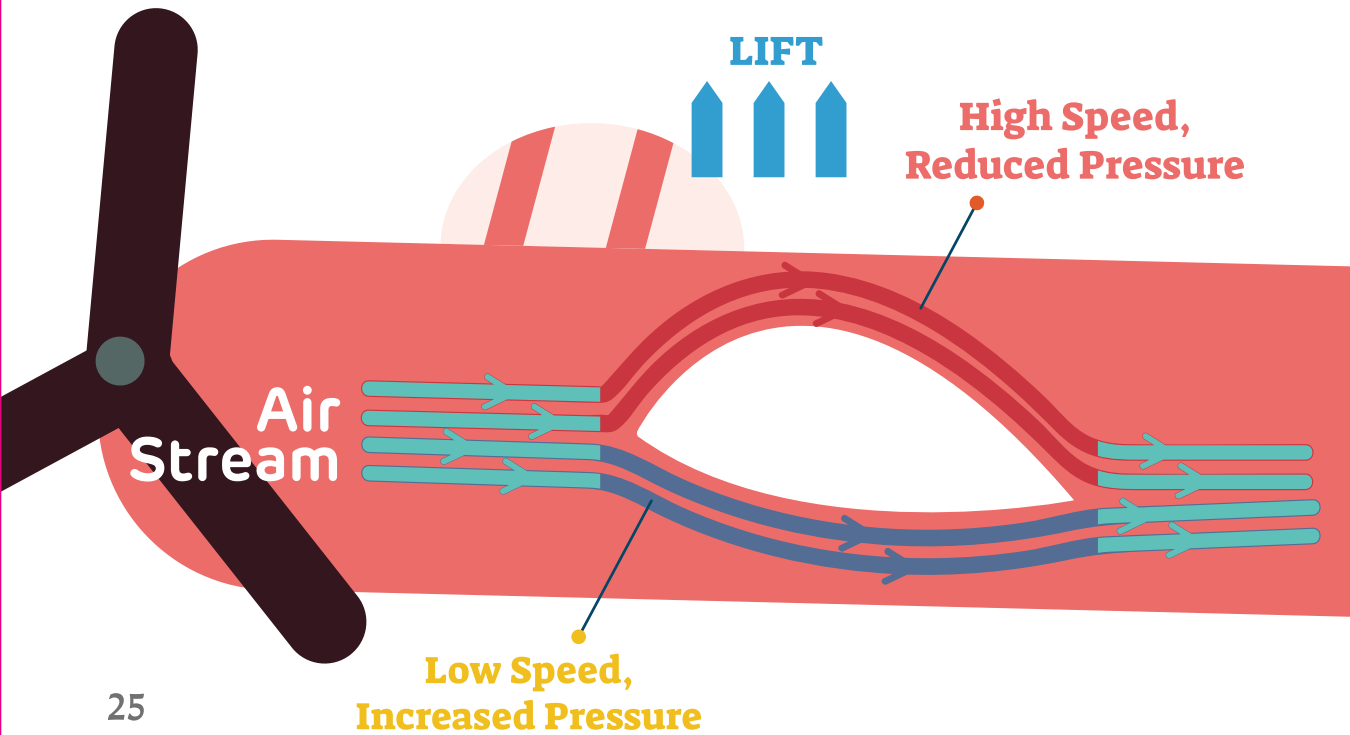

Drag

In addition to the "Lift" there is another force applied by the wind on the plane, the "Drag". This force is directed backward, it is due to the resistance of the wind on the airplane. It is very important to lower the "Drag" as it greatly affect flight performances and fuel consumption.

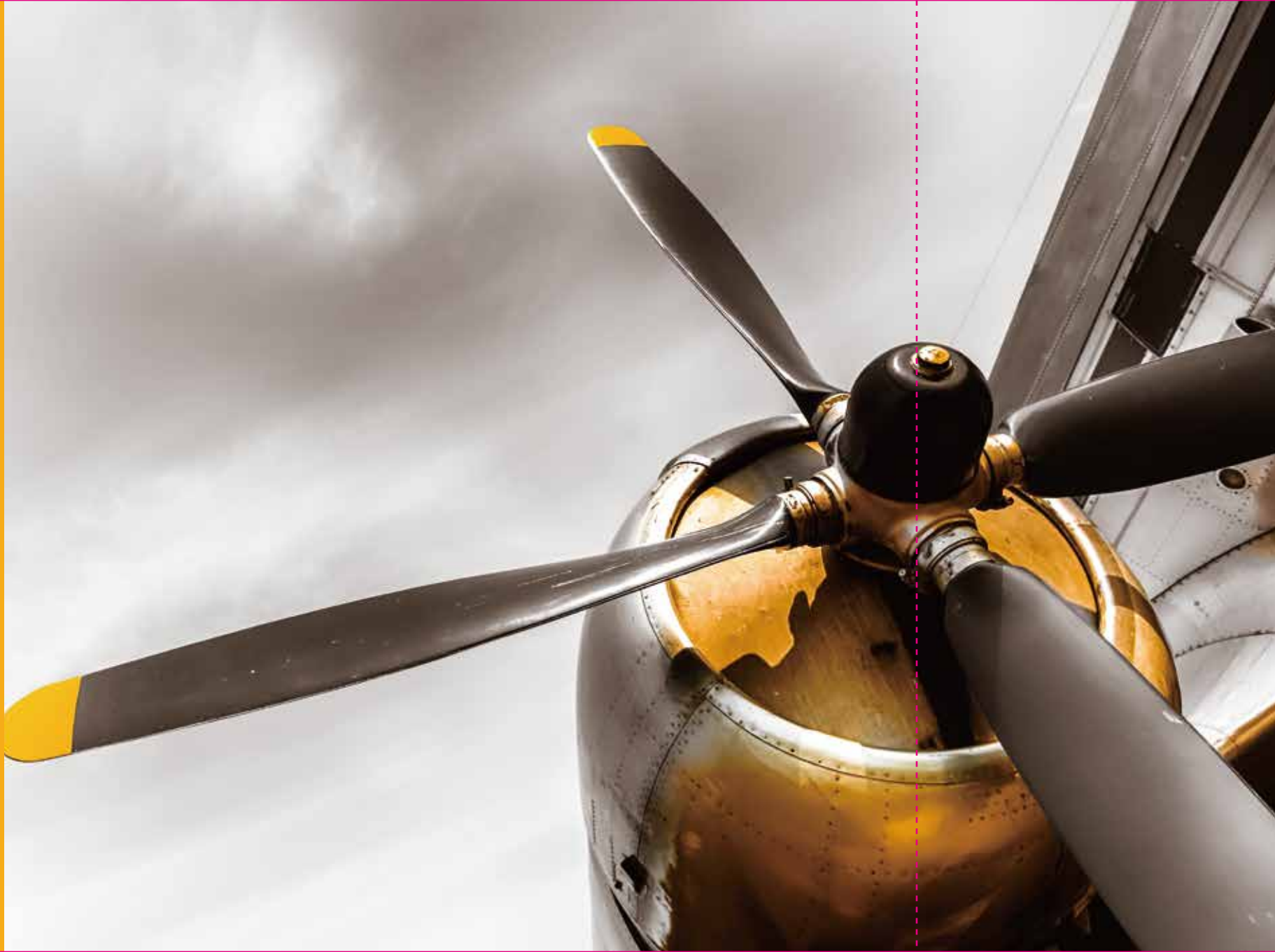

Read to be inspired!

PISTON ENGINES

There exist two kinds of aircraft engines: "Piston engines" and "Gas turbine". Piston engines are generally used for small size airplane due to their light weight. The engine is similar to car engine but instead of turning wheels it turns a propeller.

Read to be inspired!



GAS TURBINES

Gas turbines are mostly found on large size airliners and military planes. Gas turbine engine don't have propeller, try to identify the type of engine next time you see a plane.





Read to be inspired!

HISTORY ABOUT THE PLANE

The model you have in your hands is inspired by the "de Havilland Canada DHC-2 Beaver". It is a high wing aircraft developed by the Havilland Canada company in 1947. It has been first used as a "bush plane", to provide passenger and flight services to remote and undeveloped areas.

Read to be inspired!



A seaplane is an STOL (Short Take Off and Landing) aircraft which has short runway requirement. Seaplanes have one or more floats mounted under the fuselage to provide buoyancy, most of them are variants from modern civilian planes. Seaplanes offer convenient and fast transportation in lakes and between islands. However, they cannot resist extreme weather condition and large waves.



PLAY • READ • INSPIRE

5 | ACTIVITIES



DIFFERENT RUBBER BAND

In your model plane, the rubber band acts as the engine transforming "elastic energy" into "mechanical energy" to spin the propeller. Three rubber bands are provided in this kit, two short ones, a little darker and stiffer, and a standard one, more elastic. Try to fly your plane with one short rubber band or combine two of them. Then try it with the standard one to see the differences.

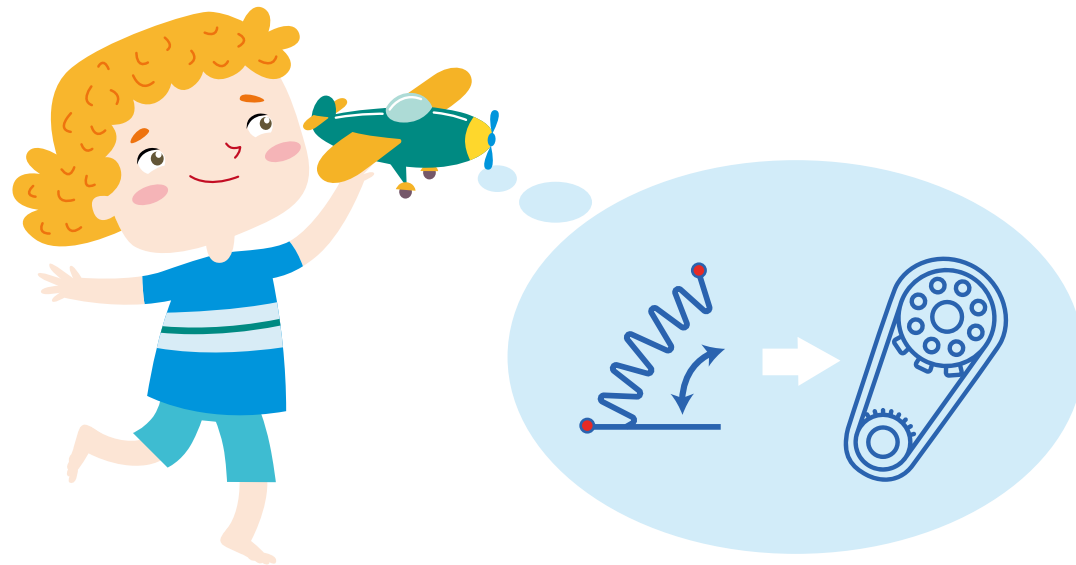

You will notice that, with the same amount of winding, the standard rubber band makes the plane flying longer and further. This is because it can store more "elastic energy", which means provide more "mechanical energy" to the propeller.

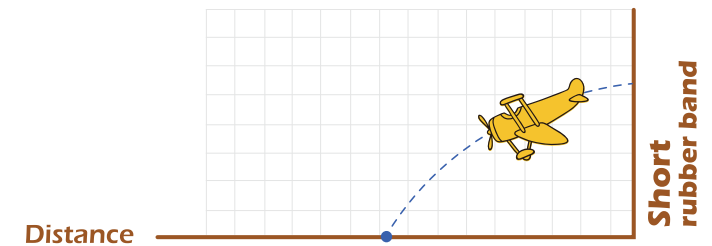
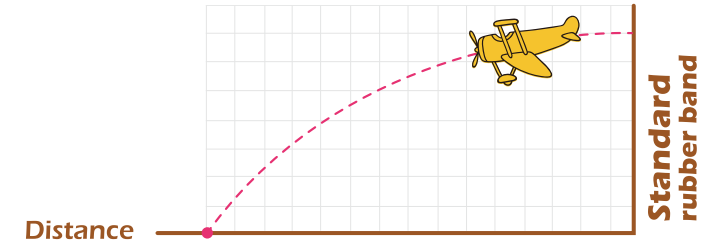

Why don't you try with other rubber bands that you have at home? Make sure the rubber band you chose is long enough and not too wide. Otherwise it could get stuck in the fuselage while winding up.

